

# Transferring Facial Expressions to Different Face Models

V. Costa Teixeira Orvalho<sup>1</sup>, Ernesto Zacur<sup>2</sup> and Antonio Susin<sup>1</sup>

<sup>1</sup>Laboratorio de Simulación Dinámica (Univ. Politècnica de Catalunya) , Barcelona, Spain

<sup>2</sup>Universitat Pompeu Fabra, Barcelona, Spain

---

## Abstract

We introduce a facial deformation system that helps the character setup process and gives artists the possibility to manipulate models as if they were using a puppet. The method uses a set of labels that define specific facial features and deforms the rig anthropometrically. We find the correspondence of the main attributes of a generic rig, transfer them to different 3D face models and automatically generate a sophisticated facial rig based on an anatomical structure. We show how the labels, combined with other deformation methods, can adapt muscles and skeletons from a generic rig to individual face models, allowing high quality physics-based animations. We describe how it is possible to deform the generic facial rig, apply the same deformation parameters to different face models and obtain unique expressions. We show how our method can easily be integrated in an animation pipeline. We end with different examples that show the strength of our proposal.

Categories and Subject Descriptors (according to ACM CCS): I.3.7 [Computer Graphics]: Three-Dimensional Graphics and Realism. Animation

---

## 1. Introduction

Facial animation is related to the interaction of muscles and skeletons beneath the skin. It is the key element to transmit individuality and personality to a character in films and video games. Therefore, to obtain physically-based animations, it is crucial to develop systems that simulate the anatomical structure of the face. Recent advances in facial synthesis show an increased interest in physics-based approaches [WF95] [KK02] [SL96]. Today, to animate a character, an experienced CG artist has to model each facial rig by hand, making it impossible to re-use the same rig in different facial models. The task is further complicated when a minor artistic change on the facial topology leads to the restarting of the rigging process from scratch. This creates a bottleneck in any CG production and leads to the research of automated methods to accelerate the process [JTDP03]. The challenge can be solved if we successfully answer the following question:

*Would it be possible to use the muscle and skeletal system created for one character in other characters ?*

We propose a deformation method to transfer the inner structure of a generic rig to individual face models, based on thin-

plate splines [Boo89] and the use of facial features labels. We tag the generic rig with landmarks on its surface (the skin) and automatically deform it, together with the muscle and skeleton structure, to fit different face models. Because all models share the same generic set of attributes, we don't need to develop unique scripts for each face. We can transfer generic rig parameters, enabling re-use of existing animation scripts. We can build models with underlying anatomical structure, skin, muscle and skeleton, for human heads or other type of creatures. The models are suitable for real-time animation based on simulation of facial anatomy.

The following section provides an overview of the related work. Section 3 defines the generic rig. Section 4 describes the deformation method that transfers the generic rig attributes to different face models. Section 5 details how to animate a 3D face model. We conclude with a discussion of our results in section 6 and ideas for future research in section 7.

## 2. Background and Related Work

Facial animation is based on ideas pioneered by P. Waters in the '70s [Par72]. Traditional approaches to animate facial models usually rely on an artist to create the key movements and then blend between those movements to obtain a fluid

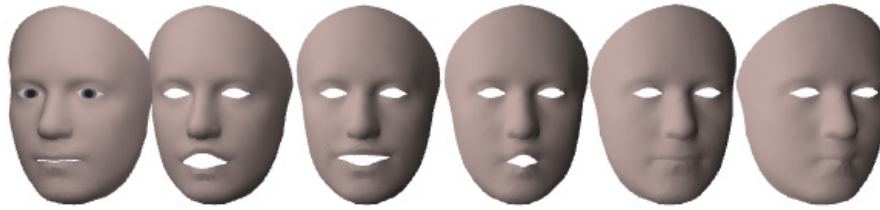

Figure 1: Generic Rig facial expression templates

motion. For instance, games are very character-driven, creating a need for high level facial animations. Due to limited resources, facial animation in games is either poor or omitted. In addition, there is an increasing demand for film quality facial expressions in games. In films, re-using the same facial rig in different models is a very time consuming task for artists.

Modeling and animation of deformable objects have been applied to different fields [ACWK04] [BK04]. *Noh et al.* [NN01] proposed several methods for transferring animations between different face models. The surface correspondence is obtained by specifying the point pairs on the models. *Pighin et al.* [FPJ98] presented a method to interactively mark corresponding facial features in several photographs of a person and to deform a generic face model using radial basis function.

Chadwick et al. [CHP89] presented a method for layered construction of flexible animated characters using *free-form deformations (FFD)* based on *Sederberg and Parry* [SP86]. This method does not require setting the corresponding features on the geometries. *Komatsu* [Kom88] also used FFD for skin deformation. *Mark Henne* [Hen90] used a layered approach, where implicit fields simulated body tissue. *Singh et al.* [SOP95] used implicit functions to simulate skin behavior. *Turner et al.* [TT93] used an elastic skin model for character animation. *Wu et al.* [WKT96] studied skin wrinkling. Other interesting approaches for high level geometric control and deformation over 3D model were introduced [Coq90] [HHK92] [SF98]. None of these methods attempted to model individual 3D muscles.

*Chen and Zeltzer* [CZ92] presented a realistic biomechanical muscle based model, using a finite element method to simulate individual muscles. The most anatomically detailed simulations have been done for the human face. Skin is generally modeled as a geometric surface, whose points move as facial expressions change. Physical simulation has been integrated into facial modeling by *Lee et al.* [LTW95], among others. *Koch et al.* [KGC\*96] described a system for simulating facial surgery using finite element models. None of these methods include animation controls that automate the character setup process in film productions.

### 3. The Generic Rig

Our method builds on a sophisticated 3D face model we call generic rig  $\mathcal{R}$  (see figure 6), designed for use within a facial animation production pipeline to accelerate the rigging process. The model is formed by different layers of abstraction: skin surface  $\mathcal{R}_S$ , muscles surfaces  $\mathcal{R}_M$ , skeleton joints  $\mathcal{R}_B$ , facial feature landmarks  $\lambda$ , skinning system and other components for representing the eyes, teeth and tongue. We can assign different attributes to each of these layers, like: weight, texture, muscle stress, etc. [Hab04]

The **generic rig**  $\mathcal{R}$  has been modeled manually and is a highly deformable structure of a face model based on physical anatomy. During the modeling process, we used facial features and regions to guarantee realistic animation and reduce artifacts.

The **surface**  $\mathcal{R}_S$  is the external geometry of the character, determining the skin of the face using polygonal surfaces composed by a set of vertices  $\mathbf{r}$  and a topology that connects them.

The generic rig is tagged with **landmarks**  $\lambda$ , distributed as a set of sparse anthropometric points. We use these landmarks to define specific facial features to guarantee correspondence between models. Our rig has 44 landmarks placed on the surface (see figure 6c) [FI87] [DDS87]

The **skeleton**  $\mathcal{R}_B$  is a group of bones positioned under the skin. It defines the pose of the head and controls lower level surface deformation.

The **muscles**  $\mathcal{R}_M$  are a group of volumes, surfaces or curves located under the skin, which control higher level surface deformation. To build our muscle structure, we selected eleven key muscles (see figure 6d) responsible for facial expressions [Fai87], out of the twenty-six that move the face.

### 4. Transferring the Generic Rig structure

We introduce a method to automatically transfer the generic rig structure and components to individual 3D face models, which can be divided in three main steps: first, we deform the generic rig surface to match the topology of the face model we want to control; then, we adapt the muscles, skeleton and attributes of the generic rig to the 3D model; finally, we bind the transferred elements to the model, obtaining an anatomic structure prepared for physically-based animation.

The face model that inherits the generic rig setup is referred as  $\mathcal{F}$ . It is defined by a face surface  $\mathcal{F}_S$ , which determines the face geometry and shape, and a set of landmarks  $\phi$  placed on  $\mathcal{F}_S$ . Like  $\mathcal{R}_S$  from the generic rig,  $\mathcal{F}_S$  is defined by a set of vertices  $\mathbf{f}$  and a topology that connects them. The landmarks are positioned manually by the artist, to guarantee correspondence with the generic rig landmarks (see section 3). Even though the generic rig has 44 landmarks, it is not necessary to use them all to transfer the rig (see results in figure 7). Starting with a landmarked face model  $\mathcal{F}$ , the rest of the structure transfer is automated as it will be detailed next.

#### 4.1. Geometric transformations

To deform the rig  $\mathcal{R}$  into  $\mathcal{F}$  we use linear and non-linear global transformations and local deformation. Linear transformations in combination with non-linear transformations, give us enough degrees of freedom (DOF) to ensure the correct match between the geometries.

Equation 1 describes the generic form of the transformations:

$$\mathbf{x}' = \begin{pmatrix} x' \\ y' \\ z' \end{pmatrix} = \begin{pmatrix} \sum_{i=1}^n w_{xi} U(\mathbf{x}, \mathbf{p}_i) + a_{x0} + a_{xx}x + a_{xy}y + a_{xz}z \\ \sum_{i=1}^n w_{yi} U(\mathbf{x}, \mathbf{p}_i) + a_{y0} + a_{yx}x + a_{yy}y + a_{yz}z \\ \sum_{i=1}^n w_{zi} U(\mathbf{x}, \mathbf{p}_i) + a_{z0} + a_{zx}x + a_{zy}y + a_{zz}z \end{pmatrix} \quad (1)$$

Following Bookstein [Boo89] [RSS\*01], we use the kernel function  $K = U(\mathbf{x}, \mathbf{p}_i) = \|\mathbf{x} - \mathbf{p}_i\|$  that minimizes the bending energy of the deformation. This transformation is called Thin Plate Spline Warping (TPS) and it is a special case of Radial Basis Function Warping [CFB97].

Solving the linear system of equations 2, we obtain  $\mathbf{w}$  and  $\mathbf{a}$  coefficients, using  $\mathbf{p}$  and  $\mathbf{q}$  correspondence, where  $\mathbf{p}$  are surface origin coordinates and  $\mathbf{q}$  are surface target coordinates. The TPS wrapping ensures the exact point matching and interpolates the deformation of other points smoothly.

$$\begin{pmatrix} K & \mathbf{p} \\ \mathbf{p}^T & 0 \end{pmatrix} \begin{pmatrix} \mathbf{w} \\ \mathbf{a} \end{pmatrix} = \begin{pmatrix} \mathbf{q} \\ 0 \end{pmatrix} \quad (2)$$

#### 4.2. Surface deformation

Given  $\mathbf{p}$  and  $\mathbf{q}$ , we define the operation:

$$\mathbf{x}' = \text{TPS}_{\mathbf{p}}^{\mathbf{q}}(\mathbf{x}) \quad (3)$$

that minimizes the energy of the surface deformation. We use the following notation,  $\mathbf{q} = \mathbf{p}|_S$ , where  $\mathbf{q}_i$  is the position of the correspondent point to  $\mathbf{p}_i$  in the geometry  $S$ .

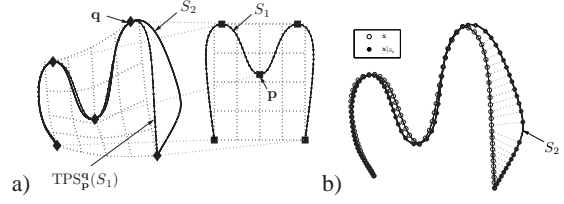

**Figure 2:** a) TPS wrap of a generic surface based on reduced set of sparse landmarks ( $S_1$ : original surface,  $S_2$ : target surface,  $\mathbf{p}$ : origin landmarks,  $\mathbf{q}$ : target landmarks); b) Sticking of the original surface to the target surface after applying the TPS. (see section 4.3)

Figure 2a shows the deformation of a surface uniformly sampled into another surface, using a reduced set of sparse landmarks. Only these landmarks will result on an exact deformation, while the rest of the surface points lay outside the target surface. Figure 3 shows the deformation of the generic rig into a face model using 10 anthropometric landmarks.

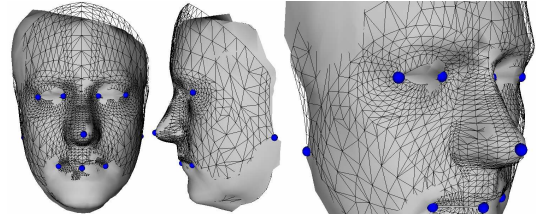

**Figure 3:** Human Face wrapping process using 10 landmarks.

#### 4.3. Obtaining a dense correspondence between surfaces

To obtain an exact deformation of every surface point, where the origin surface matches the target surface, we apply a local deformation to every point of the origin surface. Then, we project every point of the wrapped surface to the closest point of the target surface. As a result, we get the correspondent point in the target surface for every vertex of the origin surface. This is called *dense correspondence* [HBH01] between surfaces.

We define in our pipeline an operation called *Stick* (STK) that computes the dense correspondence of points  $\mathbf{r}$ , between the generic rig  $\mathcal{R}$  and the face model  $\mathcal{F}$ :

$$\mathbf{r}|_{\mathcal{F}} = \text{STK}_{\mathcal{F}_S} \left( \text{TPS}_{\lambda}^{\phi}(\mathbf{r}) \right) \quad (4)$$

This operation can present undesirable folds in areas with high curvature or if the distance between origin and target points is large. Lorenz and Hilger worked on solutions to avoid these folds [LK00] [HPL04]. Fortunately, we didn't come across this problem in the many tests we performed on different face models: human and cartoon.

#### 4.4. Deforming Layer Structures

Based on the dense correspondence between  $\mathcal{R}_S$  and  $\mathcal{F}_S$ , we can deform the generic rig muscles  $\mathcal{R}_M$  and skeleton  $\mathcal{R}_B$ . This correspondence avoids placing additional landmarks on the muscles or on the skeleton structure. Figure 4 shows that the wrap based on dense correspondence keeps the relationship between the structure and the surfaces better than the wrap based on sparse landmarks

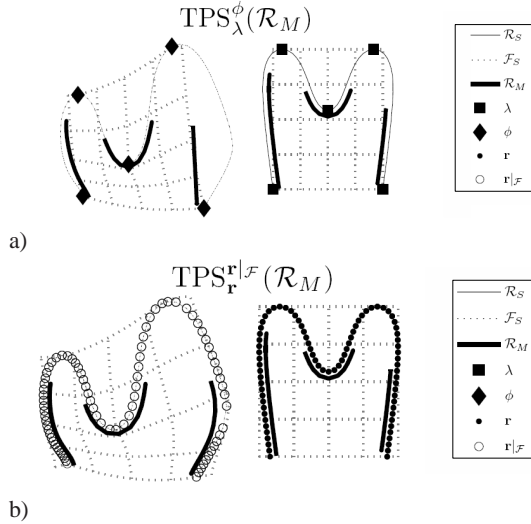

**Figure 4:** Wrapping structure with a) sparse correspondences (landmarks); b) dense correspondences.

#### 4.5. Attribute Transfer

The generic rig  $\mathcal{R}$  has a set of attributes on the surface nodes  $\mathbf{r}$  defined as scalar or vectorial fields. We have to transfer each of these attributes to surface  $\mathcal{F}_S$ . For each surface vertex  $\mathbf{f}_i$ , we find its closest point on  $\mathcal{R}_S|_{\mathcal{F}}$ , get the interpolated value and assign it to  $\mathbf{f}_i$ .

Figure 11a shows the transferred weights that influence the movement of the jaw bone. Figure 11b shows a region labeling transfer. Both figures show the attributes transfer from the generic rig to the cartoon, with different triangulations.

#### 4.6. Skinning

In animation, skinning is the process of binding deformable objects to a skeleton [Sch02]. In some software packages it is also known as envelope or birail. After skinning, the deformable object that makes up the surface is called the character's skin, and the deformable objects under the skin, which influence and shape it, are called the muscles.

The output of the skinning process is a character model setup, with the skeleton and muscles controlling the deformations. The positioning of the muscles has two goals: build an inner structure that correctly reflects the character's appearance and enable the projected facial animations with

minimum effort. The deformations of the character's skin, produced by the movements of the skeleton and muscles, allows physically-based animation.

Our skinning method uses the generic rig weight attributes to automatically attach the previously deformed skeleton and muscles to the face model  $\mathcal{F}$ .

#### 4.7. Method Overview

$\mathcal{R} \leftarrow$  Generic Rig  
 $\mathcal{F} \leftarrow$  Face Model  
 $\lambda \leftarrow$  Generic Rig Landmarks  
 $\phi \leftarrow$  Face Model Landmarks

$\mathcal{R}'_S \leftarrow \text{TPS}_\lambda^\phi(\mathcal{R}_S)$   
 $\mathbf{r}|_{\mathcal{F}} \leftarrow \text{STK}_{\mathcal{F}}(\mathcal{R}'_S)$   
 $\mathcal{F}_M \leftarrow \text{TPS}_{\mathbf{r}|_{\mathcal{F}}}(\mathcal{R}_M)$   
 $\mathcal{F}_B \leftarrow \text{TPS}_{\mathbf{r}|_{\mathcal{F}}}(\mathcal{R}_B)$   
 $\mathbf{f} \leftarrow \text{attributeTransfer}(\mathbf{r}|_{\mathcal{F}})$   
 $\mathcal{F} \leftarrow \text{skinning}(\mathcal{F}_S, \mathcal{F}_M, \mathcal{F}_B)$

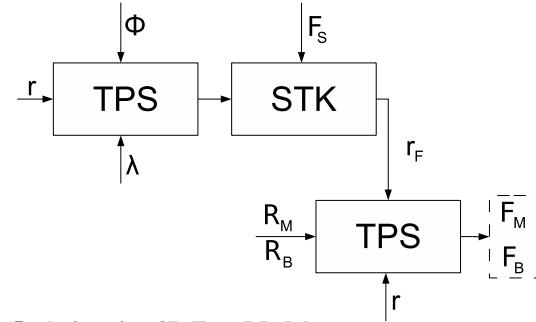

#### 5. Animating 3D Face Models

We employ the method describe in section 4 to construct the character setup of the 3D face model. After fitting the generic rig's attributes to the character, we are able to:

- manipulate the model to adjust animation parameters;
- animate the model using the generic rig's pre-defined animations.

To manipulate the model, we use the controls defined in the generic rig that are transferred to the model. Artists can adjust different controls, like cluster and flexor deformer. We can also use facial expressions templates, defined in the generic rig, to create blend shapes and to generate animations. Our method has a natural correspondence between different expressions of the same face; it avoids the need of extra parametrization to adapt the model from one facial expression to another. We can also use pre-defined animations by transferring the generic rig's animation scripts to the model.

*Facial expressions* are caused by facial muscles contraction. The skin modifies its initial shape depending on the underlying muscle and skeleton behavior. We create a set of

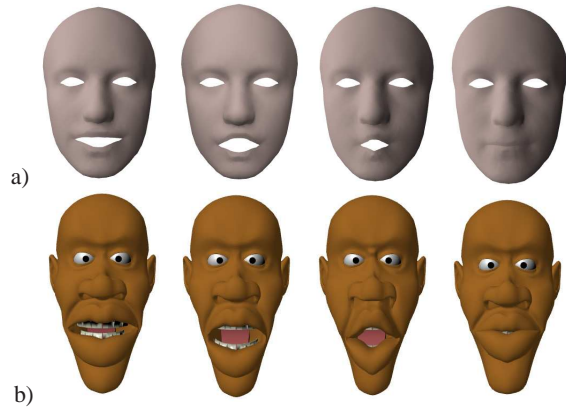

**Figure 5:** a) *Generic Rig facial expressions templates*; b) *Cartoon facial expressions using Generic Rig templates*

facial expressions that can be transferred to different models. Figure 5a shows different facial expression templates and figure 5b shows the result of applying the generic rig's facial expression to our cartoon model.

There are different techniques to create facial expressions [Fai87] [JTDP03]. Our approach consists of transferring the animation controls and expression templates from the generic rig to the character. During the transfer, we keep a consistent coordinate system between the generic rig and the model. To animate the rig, we translate and rotate the muscles and the skeleton. We also use a set of deformers that allow artists to control the rig at a higher level. The main steps of our animation process are:

1. **Create Templates:** translate and rotate muscles and skeletons at the generic rig to create different facial expression templates;
2. **Tuning:** adjust deformers to optimize the model;
3. **Generate Script:** use blend shapes to create animations between the templates and generate animation scripts;
4. **Animate Model:** at this step, we assume that the model has already inherited the generic rig's setup (see section 4); now we can run the animation scripts.

## 6. Results and Conclusion

The deformation methods have been implemented in C++ as a plug-in for Maya 7.0 software. Our method speeds up the character setup and animation pipeline, since we drive all face models by deformation of the same generic rig. This allows using the facial expressions created in the rig on different models. To obtain unique deformation in each face, both generic rig's muscles and skeleton can be adjusted in the different facial regions.

In contrast with other methods [KK02] that landmark the skin, muscle and skull, we only landmark the skin surface because we obtain dense correspondence. This simplifies and eases the setup of the character. Our results indicate

that anthropometric modeling is a good approach to generate physically-based animations.

Our *generic rig* has 1800 points, 44 landmarks, 4 bones and 11 muscles, and is based on human anatomy (see figure 6). The *human model* is a 3D scan of a human face. It has 1260 points and 10 landmarks (see figure 7). Figure 7b displays the wireframe mesh. We use 10 landmarks to transfer the rig structure (see figure 7d). Figure 14 shows the wrapping process.

The *cartoon model* has 1550 points and 44 landmarks (see figure 8). Figure 8 shows the muscle transfer and figure 11 shows the attribute transfer of the weight and region label. Based on the weights of figure 11a, figure 12 shows the transfer of a facial expression. The graphics on figure 10 display the distance between the muscle and the skin surface points, on the generic rig (solid line) and on the face model (dots). Results show that the wrapping works better for human faces. To explore the limits of our method, figure 9 confirms that the wrapping and landmarks fitting work robustly in non-human faces with extreme facial appearance. We use 12 landmarks to transfer the rig structure to a goat (see figure 9d).

## 7. Future Work

For further automation of the character setup process, we will create a set of sophisticated facial expression templates and an intuitive GUI running in Maya. Our generic rig will include different types of muscles. We will add support on our plug-in for NURBS surfaces. We will allow the models to inherit the animation controls from the generic rig. The purpose of these animation controls is to reduce: the complexity to obtain facial motion, the effort required by artist and computation time.

Our final goal is to automate the character setup process within an animation pipeline, without changing the input model, enabling the artists to manipulate it as if they were using a puppet. The model can be created by an artist or scan generated. This will further speed up the creation of animations, because it will require no additional rigging.

## 8. Acknowledgement

Special thanks goes to João Orvalho for his review, unconditional support and motivation. We also thank Dani Fornaguera, Marco Romeo and Carlos for their valuable comments and 3D Models. This research is partially supported by CICYT grant TIN2004-08065-C02-01.

## References

- [ACWK04] ANGELIDIS A., CANI M., WYVILL G., KING S.: Swirling-sweepers: Constant-volume modeling. Pacific Graphics 2004.
- [BK04] BOTSCH M., KOBELT L.: An intuitive framework for real-time freeform modeling. ACM Transactions on Graphics (TOG), SIGGRAPH '04, pp. 23(3), 630–634.

- [Boo89] BOOKSTEIN F.: Principal warps: Thin-plate splines and the decomposition of deformations. *IEEE Trans. on Pattern Analysis and Machine Intelligence*, vol. 11, no. 6, pp. 567–585.
- [CFB97] CARR J., FRIGHT W., BEATSON R.: Surface interpolation with radial basis functions for medical imaging. vol. 16, *IEEE Trans. on Medical Imaging*.
- [CHP89] CHADWICK J., HAUMANN D., PARENT R.: Layered construction for deformable animated characters. *SIGGRAPH '89*.
- [Coq90] COQUILLART S.: Extended free-form deformations: A sculpturing tool for 3d geometric modeling. *Proc. SIGGRAPH 90' Conf., ACM Computer Graphics*, pp. 187–196.
- [CZ92] CHEN D., ZELTZER D.: Pump it up: Computer animation based model of muscle using the finite element method. *SIGGRAPH '92*, pp. 89–98.
- [DDS87] D. DECARLO D. M., STONE M.: An anthropometric face model using variational techniques. *Proc. SIGGRAPH '98*, pp. 67–74.
- [Fai87] FAIGIN G.: *The artist's complete guide to facial expressions*. Watson-Guption Publications, New York, pp. 67–74.
- [FI87] FARKAS LESLIE M., IAN: *Anthropometric facial proportions in medicine*. Charles Thomas Ltd., USA.
- [FPJ98] F. PIGHIN D. LISCHINSKI R. S. D. S., J.HECKER: Synthesizing realistic facial expressions from photographs. *Proc. SIGGRAPH '98 Conf.*, pp. 75–84.
- [Hab04] HABER J.: *Anatomy of the human head*. *SIGGRAPH 2004, Course Notes: Facial Modeling and Animation*.
- [HBH01] HUTTON T., BUXTON B., HAMMOND P.: Dense surface point distribution models of the human face. *IEEE Workshop on Mathematical Methods in Biomedical Image Analysis*, pp. 153–160.
- [Hen90] HENNE M.: *A constraint-based skin model for human figure animation*. Master thesis, University of California Santa Cruz, Santa Cruz.
- [HHK92] HSU W., HUGUES J., KAUFMAN H.: Direct manipulation of free-form deformation. *Proc. SIGGRAPH '92, ACM Press*, pp. 177–184.
- [HPL04] HILGER K. B., PAULSEN R. R., LARSEN R.: Markov random field restoration of point correspondences for active shape modelling. *SPIE - Medical Imaging*.
- [JTDP03] JOSHI P., TIEN W., DESBRUN M., PIGHIN F.: Learning controls for blend shape based realistic facial animation. *Eurographics/SIGGRAPH Symposium on Computer Animation, ACM Press*, pp. 187–192.
- [KGC\*96] KOCH R., GROSS M., CARLS F., BUERIN D. V., FRANKHAUSER G., PARISH Y.: Simulating facial surgery using finite element models. *SIGGRAPH '96*, pp. 421–428.
- [KK02] K. KÄHLER J. HABER H. Y. H. S.: Head shop: Generating animated head models with anatomical structure. *ACM SIGGRAPH/Eurographics symposium on computer animation*, pp. 55–63.
- [Kom88] KOMATSU K.: Human skin model capable of natural shape variation. In *The Visual Computer* (March 1988), vol. 3, Springer Berlin / Heidelberg, pp. 265–271.
- [LK00] LORENZ C., KRAHNSTÖVER N.: Generation of point-based 3d statistical shape models for anatomical objects. vol. 77, *Computer Vision and Image Understanding: CVIU*, pp. 175–191.
- [LTW95] LEE Y., TERZOPOULOS D., WATERS K.: Realistic modeling for facial animation. *SIGGRAPH '95*, pp. 55–62.
- [NN01] NOH J., NEUMANN U.: Expression cloning. *SIGGRAPH '01, ACM SIGGRAPH*, pp. 277–288.
- [Par72] PARKE F.: *Computer generated animation of faces*. vol. 1, *ACM Press.*, pp. 451–457.
- [RSS\*01] ROHR K., STIEHL H., SPRENGEL R., BUZUG T., WEESE J., KUHN M.: Landmark-based elastic registration using approximating thin-plate splines. vol. 20, *IEEE Trans. on Medical Imaging*, pp. 526–534.
- [Sch02] SCHLEIFER J.: Character setup from rig mechanics to skin deformations: A practical approach. *Proc. SIGGRAPH '02, Course Note*.
- [SF98] SINGH K., FIUME E. L.: Wires: a geometric deformation technique. *Proc. SIGGRAPH 98' Conf., ACM Computer Graphics*, pp. 405–414.
- [SL96] SZELISKI R., LAVALLEE S.: Matching 3d anatomical surfaces with non-rigid deformation using octree splines. *International Journal of Computer Vision* 18,2, pp. 171–186.
- [SOP95] SINGH K., OHYA J., PARENT R.: Human figure synthesis and animation for virtual space teleconferencing. *Virtual Reality Annual International Symposium '95. IEEE*, pp. 118–126.
- [SP86] SEDERBERG T., PARRY S.: Free-form deformation of solid geometric models. *Proc. SIGGRAPH 86' Conf., ACM Computer Graphics*, pp. 151–160.
- [TT93] TURNER R., THALMANN D.: The elastic surface layer model for animated character construction. *Proceedings of Computer Graphics International '93*, pp. 399–412.
- [WF95] WATERS K., FRISBIE J.: A coordinated muscle model for speech animation. *Proc. Graphics Interface '95*, pp. 163–170.
- [WKT96] WU Y., KALRA P., THALMANN N.: Simulation of static and dynamic wrinkles of skin. In *Proceedings of Computer Animation '96*, pp. 90–97.

**Transferring a Labeled Generic Rig to Animate Face Models**

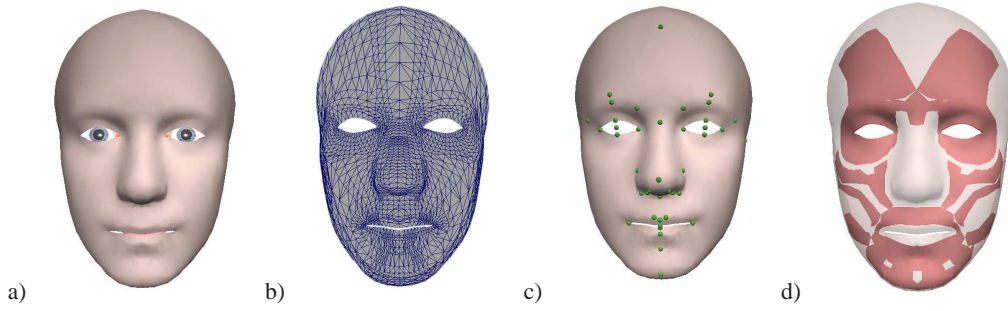

**Figure 6:** Generic Rig a) textured; b) wireframe; c) 44 landmarks; d) muscles.

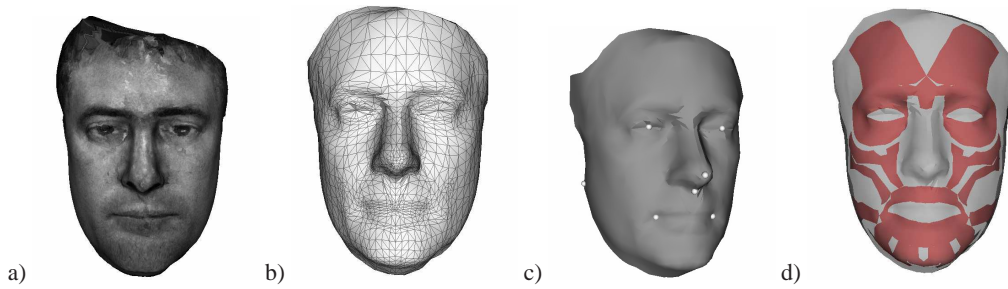

**Figure 7:** Human a) textured; b) wireframe; c) 10 landmarks; d) muscles.

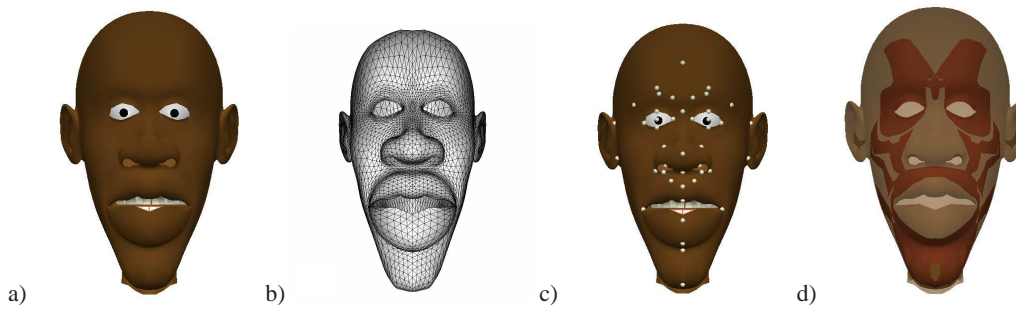

**Figure 8:** Cartoon a) textured; b) wireframe; c) 44 landmarks; d) muscles.

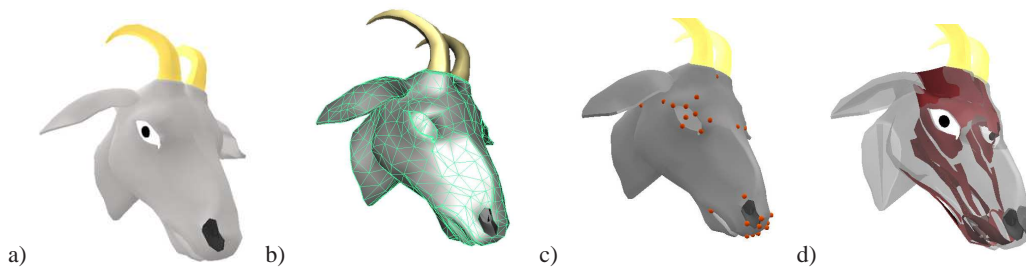

**Figure 9:** Animal a) textured; b) wireframe; c) 44 landmarks; d) muscles.

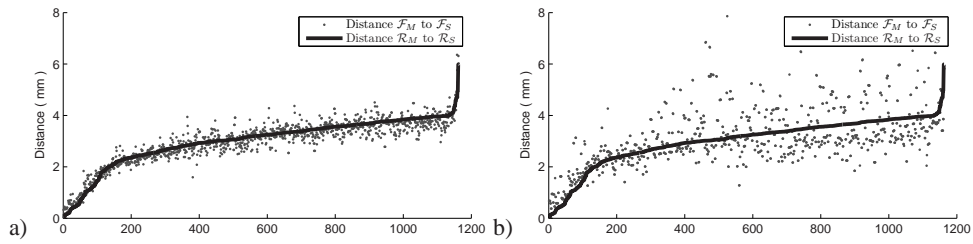

**Figure 10:** Distance between muscle and skin surfaces on the generic rig and on the model a) Human model; b) Cartoon model.

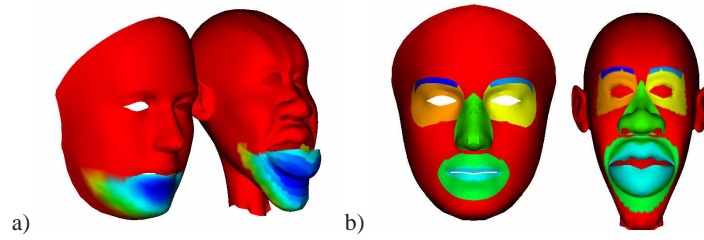

**Figure 11:** Attribute transfer from generic rig to cartoon model a) weight of the jaw bone (red is  $w = 0$ , blue is  $w = 1$ ); b) region labels.

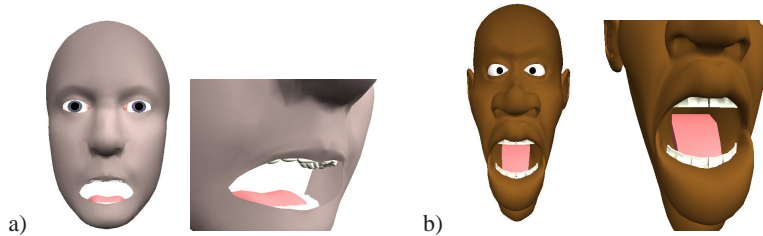

**Figure 12:** Facial Expression a) Generic Rig and close up; b) Cartoon and close up.

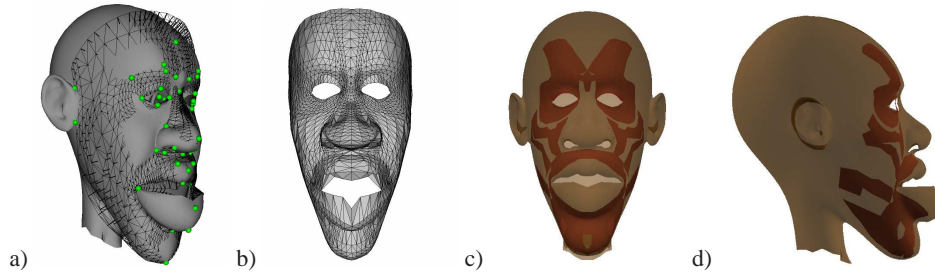

**Figure 13:** Cartoon Deformation a) TPS and Stick Lines; b) Cartoon after STK; c) Muscles transfer front view; d) Muscles transfer side view.

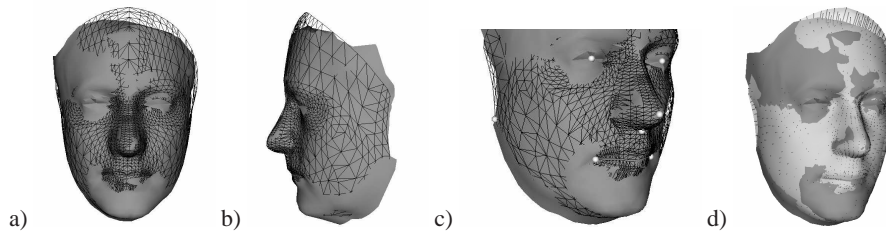

**Figure 14:** Human Face Deformation with 10 landmarks a) TPS front view; b) TPS side view; c) close up; d) dense correspondence after STK.